

Data Sheet



Article number: 604142015009

Description: Timing belt pulley with hub
HTD 15 5M 9

Measures

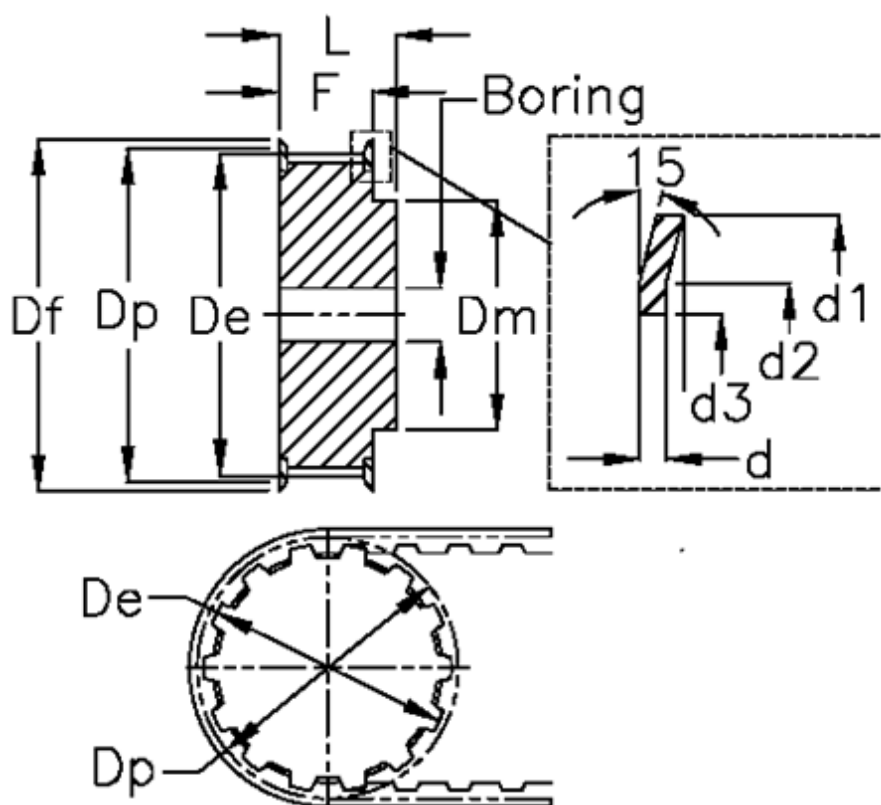

Bore = 6	Dp = 23.87
d = 1	F = 14.5
d1 = 28	Flange type = F09
d2 = 24	L = 20
d3 = 17.8	Tooth number = 15
De = 22.73	Type = 5M
Df = 28	Weight = 0.042
Dm = 16	Width = 09